

7th Infantry Division (Light)



**Table of Organizational
and
Infantry Battalion's MTOE**

Distinctive Unit Insignia for units of the 7th Infantry Division (Light)



7 Infantry Division



9th Infantry
Regiment



17th Infantry
Regiment



21st Infantry
Regiment



27th Infantry
Regiment



9th Cavalry
Regiment



15th Field Artillery
Regiment



8th Field Artillery
Regiment



123rd Aviation
Regiment



7th Aviation
Battalion



7th Medical
Battalion



7th S & T
Battalion



13th Engineer
Battalion



62nd Air Defense
Artillery Regiment



107th MI
Battalion



127th Signal
Battalion



707th
Maintenance
Battalion

INDEX

- Divisional Nickname, motto, song and sayings
- Table of Organization
- Modification Table Of Equipment:

Updated MTOE: 07015LFC07, FC 1488; Effective: 21 October 1987

- Infantry Battalion (Light)
 - Headquarters and Headquarters Company
 - Anti-Armor Platoon (TOW 2)
 - Scout Platoon
 - Mortar Platoon (81mm)
- Infantry Company (Light)
 - Headquarters Platoon
 - Infantry Platoon

7th Infantry Division (Light)

Nicknames, Motto, and Sayings

- **Nickname:**
 - Bayonet Division
- **Division song**
 - Arirang , Korea Folk Song
- **PHILOSOPHY**
 - Train to Fight, Fight to win!
- **DIVISIONAL SAYINGS**
 - Light Fighter
 - Light, Silent, and Deadly
 - Masters of the Night

Units

9 Inf Regt	2 Bde	3 Bde	DIVARTY	DISCOM	Aviation Bde	Divisional Units	
HHC	HHC	HHC	HHC	HHC/ DMMC	HHC	2-62 ADA	HHC
1- 9 Inf	4-21 Inf	3-17 Inf	2-8 FA (1 Bde)	707 MSB	7 Avn Bn	7th LRSD Company	107 MI Bn
2-9 Inf	2-27 Inf	4-17 Inf	6-8 FA (2 Bde)	7 FSB	1-123 Avn	13 Engineer BN (Combat)	7 MP Company
3-9 Inf	3-27 Inf	4-21 Inf	7-15 FA (3 Bde)	79 FSB	3-123 Avn	7 Chemical Company	7 Division Band
			B/ 15 FA (GS)	207 FSB	2-9 Cav	2-10 Cav	127 Signal Bn
				E/ 123 Avn		7 Medical Bn	
				519th Maintenance Co (Missile)			
Officially listed as 1 Bde			Note: (# Bde) identifies the Bde supported	Note: the FSB consisted of 1 Medical, 1 Maintenance, 1 S&T companies			

7 Infantry Division Light

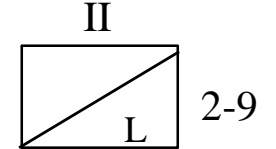
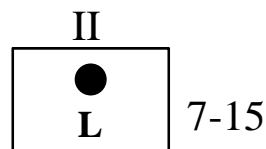
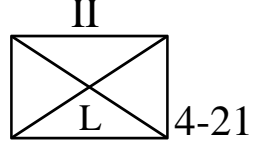
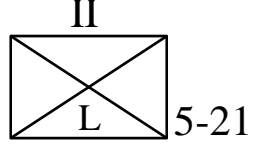
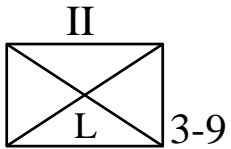
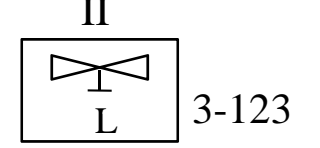
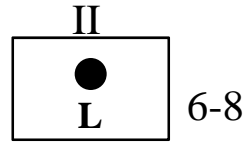
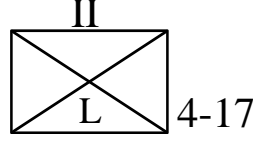
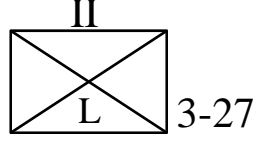
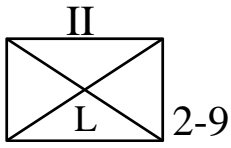
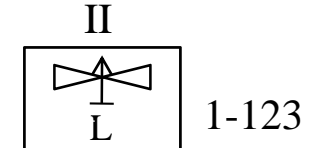
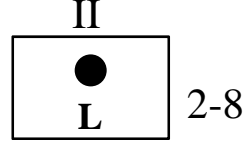
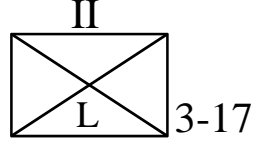
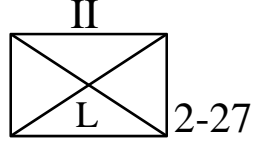
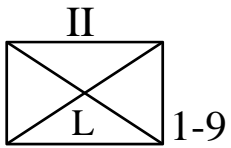
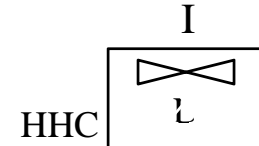
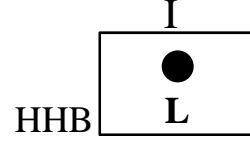
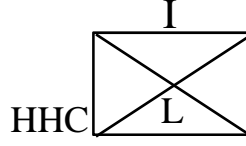
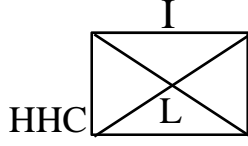
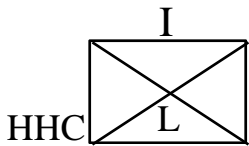
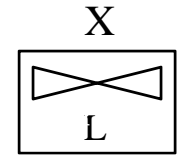
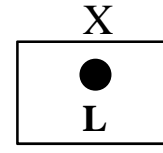
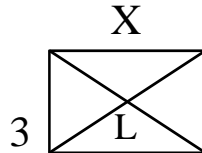
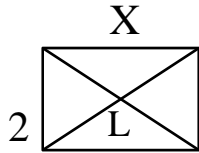
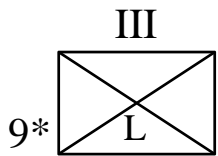
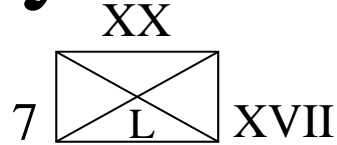

9 Inf Regt
is also referred
To as 1 Bde

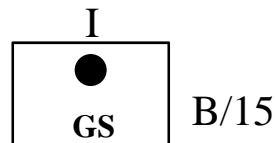

7 Infantry Division Light

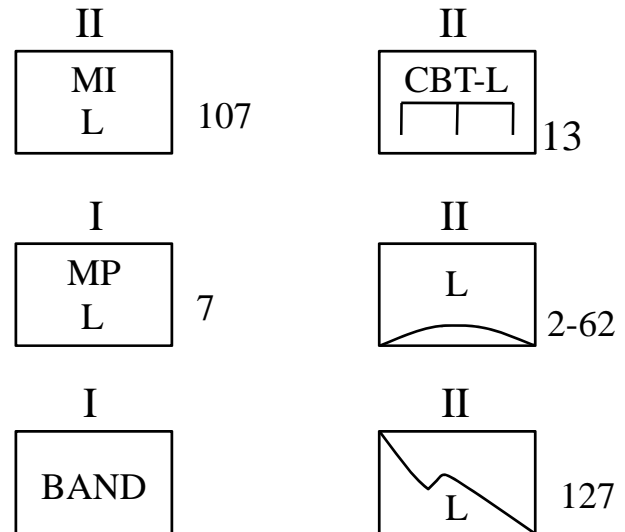
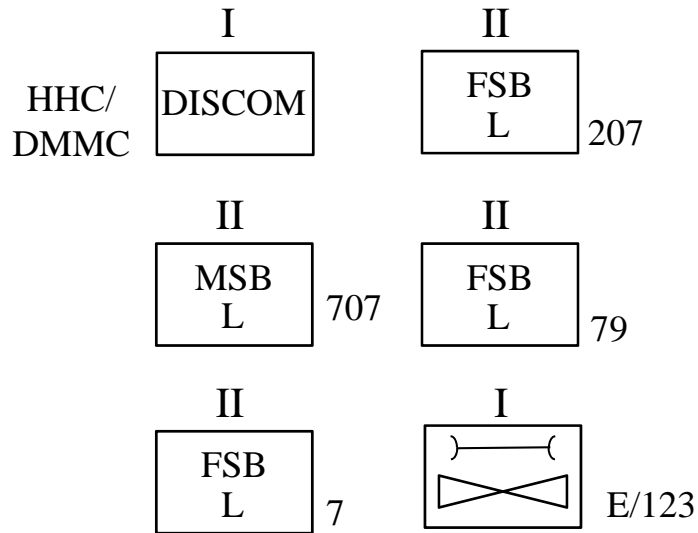
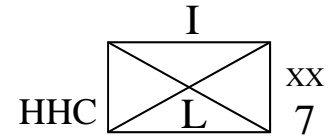
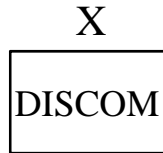

Modification Table Of Equipment

- This is the MTOE for all Infantry Battalions Light assigned to 7th Infantry Division Light
- The following charts provides basic information
 - Such as personnel assigned, major weapon systems
- Issued 21 June 1988
- Updated MTOE: 07015LFC07, FC 1488
- Effective: 21 October 1987

Infantry Battalion Light

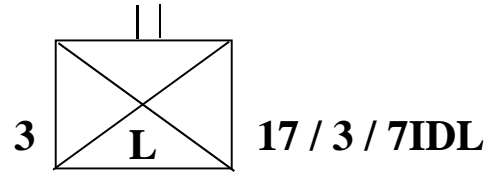

Assigned:
Officer: 30
Warrant: 1
Enlisted: 520

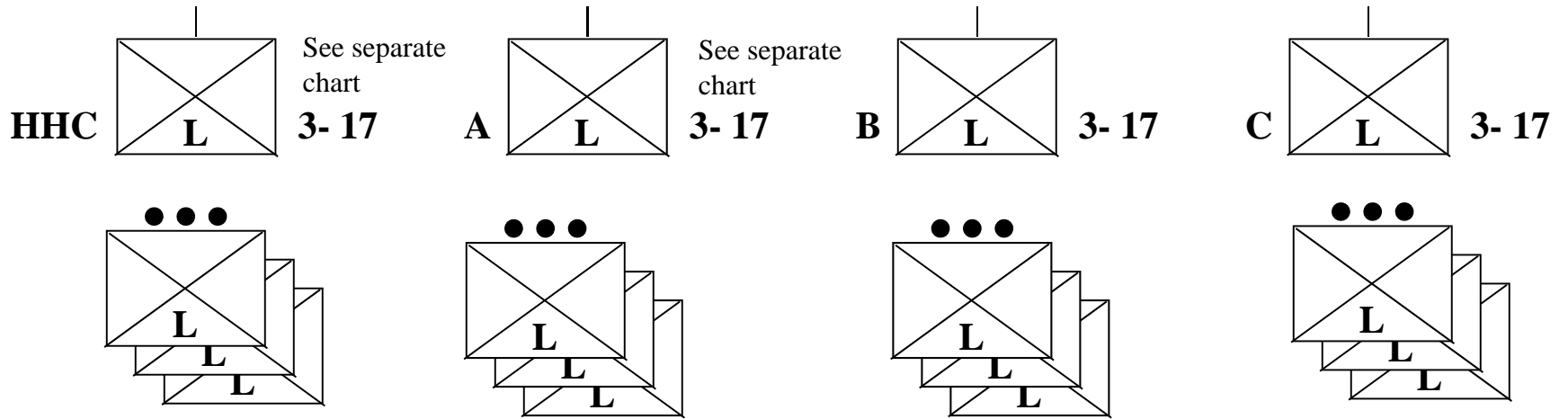

HHC Infantry Company Light

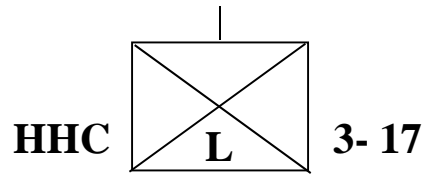

Officer: 19
Warrant: 1
Enlisted: 144

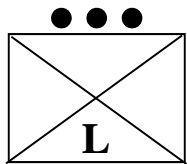

Officer: 1
Enlisted: 8

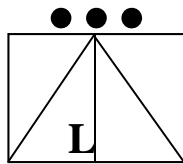

Officer: 1
Enlisted: 15

See separate
chart

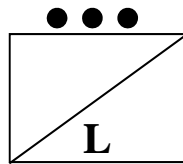

Officer: 1
Enlisted: 17

See separate
chart

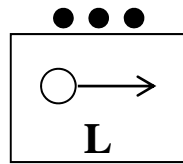

Officer: 1
Enlisted: 26

See separate
chart

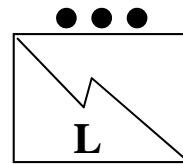

Officer: 1
Enlisted: 15

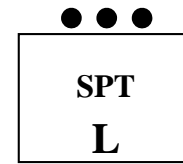

Officer: 1
Enlisted: 16

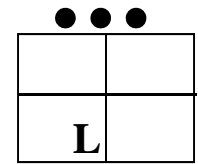

Officer: 1
Warrant: 1
Enlisted: 8

Battalion HQ

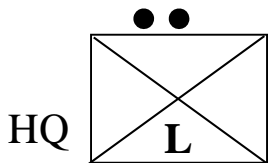

Officer: 3
Enlisted: 4

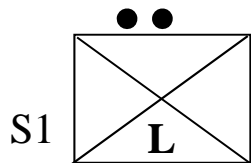

Officer: 1
Enlisted: 8

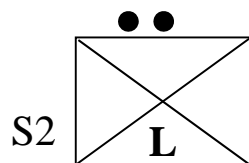

Officer: 1
Enlisted: 3

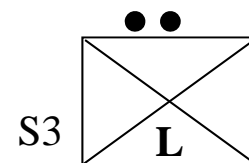

Officer: 3
Enlisted: 8

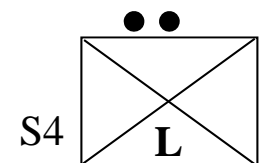

Officer: 1
Enlisted: 5

Note: By MTOE the Officer: (S1, S2, S3, S4) fall under Bn Command group

Anti-Armor Platoon Light TOW II

Officer: 1
 Enlisted: 20
 HMMWV: 2
 M998; M1038
 HMMWV: 4
 M966
 M220A2: 4
 MK 19 mode 3: 4
 M16A2: 16

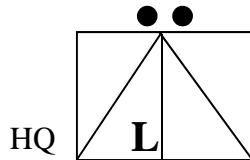
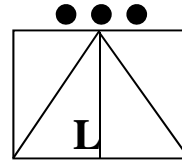

Plt Ldr: 1 (1LT)
 Plt Sgt: 1 (SFC)
 Driver/RTO: 2 (PFC)
 HMMWV: 2
 M998; M1038
 M16A2: 4

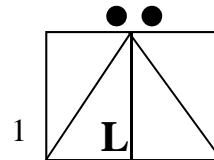

Sect Ldr; 1 (SSG)
 Sqd Ldr: 1 (SGT)
 Gunner: 2 (SPC)
 Loader/Driver: 2
 HMMWV (M966): 2
 M220A2; 2 (TOW 2)
 MK 19 mod 3: 2 (added: 1990)
 M16A2: 6

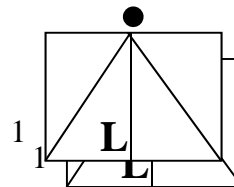
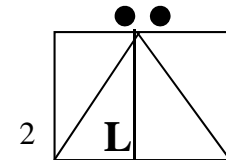

Scout Platoon Light

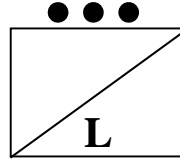

Officer: 1
Enlisted: 17
M16A2: 18
M24: 3

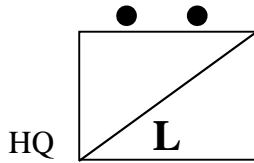

HQ

Plt Ldr: 1 (1LT)
Plt Sgt: 1 (SFC)
Driver/RTO: 2 (PFC)
HMMWV: 2
M998; M1038
M16A2: 4

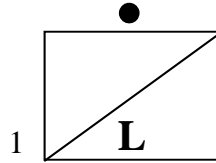

1

Enlisted: 5

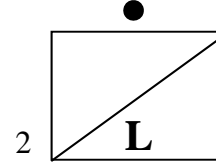

2

Enlisted: 5

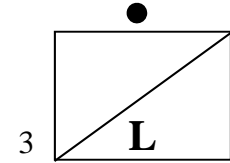

3

Enlisted: 5

Mortar Platoon Light

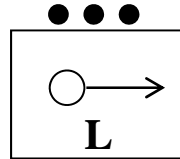

Officer: 1
Enlisted: 17
M16A2: 27
M252: 4 (81mm mortar)
HMMWV: 8

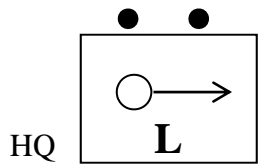

HQ

Officer: 1
Enlisted: 6
HMMWV: 2
M16A2: 7

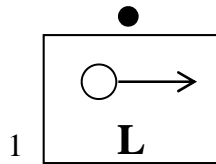

1

Enlisted: 5
HMMWV:
M252: 1
M16A2: 5

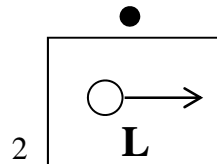

2

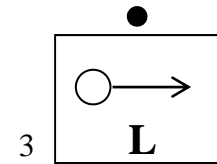

3

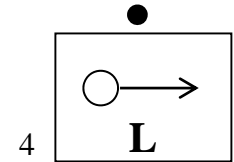

4

Infantry Company Light

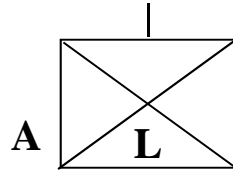

Assigned:

Officer: 4

Enlisted: 125

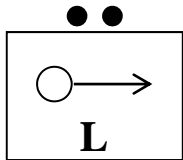
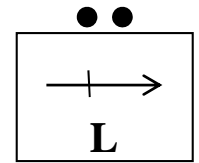
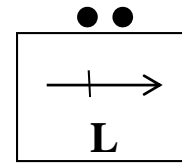
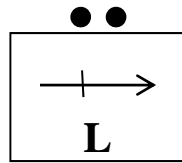
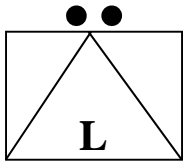
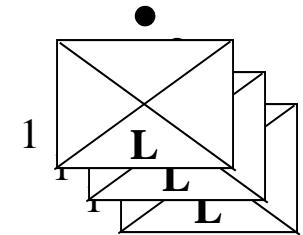
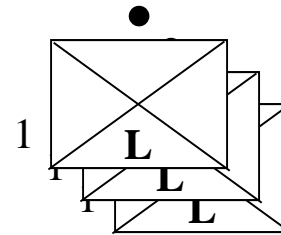
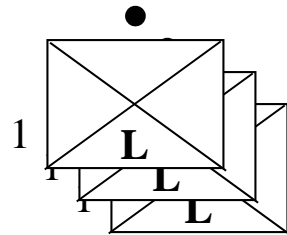
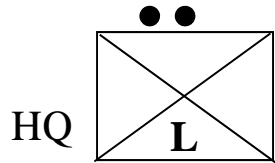
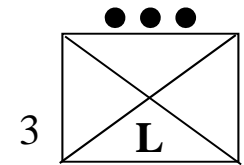
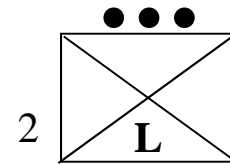
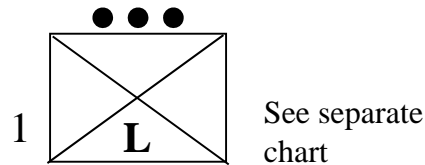
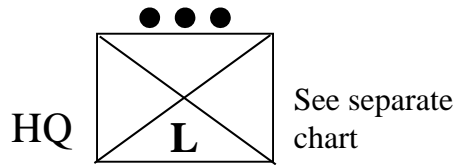

HQ Platoon Infantry Company

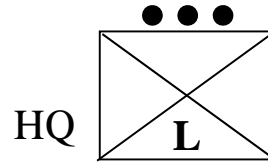

Assigned:
Officer: 2
Enlisted: 25

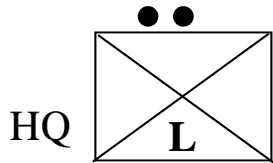

Cdr: 1 (CPT)
XO: 1 (1LT)
1Sgt: 1 (1Sgt)
Commo: 1
NBC: 1
Sply: 1

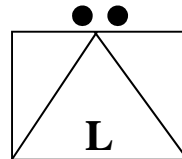

Sec Ldr: 1
Tm. Ldr: 3
A/A SPC: 6
Asst. A/A SPC: 3
M16A2 :
Dragon: 6

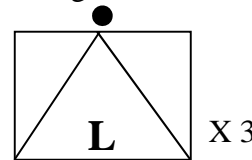

Enlisted: 4
Weapon:
M16A2:
Dragon: 2

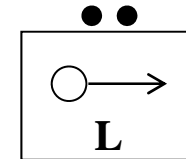

Sec Ldr: 1
Sqd Ldr:
Gunner: 2
Ammo Bearer; 2
M16A2:
M224, 60mm Mortar: 2

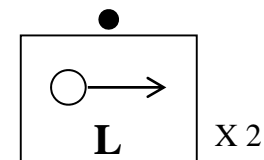

Enlisted: 3
Weapon:
M16A2:
M225 (60mm): 1

Infantry Platoon Light

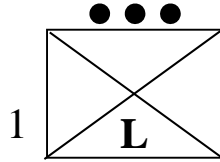

Assigned:
 Officer: 1
 Enlisted: 33

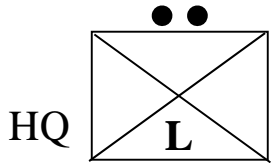

Plt Ldr: 1
 Plt Sgt : 1
 Ratello: 1
 M16A2: 3

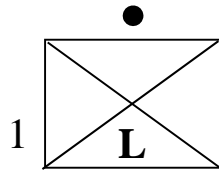

Sqd Ldr: 1
 Tm Ldr: 2
 Rifleman: 2
 Auto Rifleman: 2
 Grenadier: 2
 M16A2: 5
 M203: 2
 M249: 2

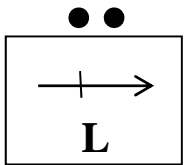
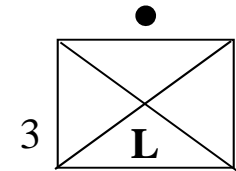
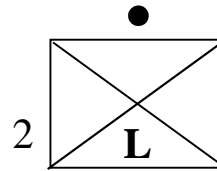

Mach. Gunner: 2
 Asst. Gunner: 2
 M16A2: 2
 M9: 2
 M60: 2